



SAFE SIDE

SAFE-TEST POINT™

High impedance protected device that allows for a closed-door metered voltage test.

SAFE-TEST POINT™ FEATURES

- ▶ **Safe-Test Point™** is a Permanent Electrical Safety Device (PESD) that allows workers a safer way to verify presence or absence of voltage from outside the electrical cabinet.
- ▶ The **Safe-Test Point™** contains four test point jacks that are hardwired directly to energy sources and allows measurement of both AC and DC voltages by inserting the insulated meter probes into any two test point jacks to take a voltage reading.
- ▶ Provides a safer and more productive method of performing Lockout/Tagout (LOTO), while exceeding NFPA 70E and meeting the OSHA energy isolation principle.
- ▶ **Safe-Test Point™** comes complete with a tool-entry dust cap and label.

FOR MORE INFORMATION VISIT PESD.COM OR CALL 1.800.280.9517



RoHS 



OPERATION

Safe-Test Point™ can be mounted on the side of the enclosure, door or flange and provides four test point jacks to allow measurement of AC/DC voltages either phase to phase or phase to ground. Following facility safety procedures, insert insulated meter probes with .080" tips into any two test point jacks to take a voltage reading with properly rated test equipment (*see Equipment Requirements*).

Installation of **Safe-Test Point™** allows workers to perform voltage presence and absence tests from outside an electrical cabinet. By following proper safety procedures, the risks of arc flash or shock hazard is reduced.

SAFE-TEST POINT™ TECHNICAL SPECIFICATIONS

SERIES	SAFE-TEST POINT™
Product Number	R-3MT-KIT-H* R-3MT-KIT-F*
Descriptions	Safe-Test Point™ with label and dust cap
Operating & Storage Temperature	Operate: -20°C to +55°C Storage: -45°C to +85°C
Operational Range AC Single or 3-Phase	0 to 600VAC phase to phase or phase to ground 0 - 400HZ
Operational Range DC or Stored Energy	0 to 600VDC, any (2) wires line-to-line or line-to-ground
Internal Resistance	102 kΩ 6 Watt, 5% Tolerance in series with each input (L1,L2,L3) wire to respective output jack maximum momentary
Correction Factor	1.02 x Test Point voltage reading with a10MΩ meter
Wire Specifications	PVC insulated with nylon jacket, 8ft, 18AWG wire, 90°C @ 1000V, UL 1452, Pre-stripped and tined
Components	3 red jacks, 1 green insulated jack, .080" DIA pin sockets, 30mm push button hole, minimum probe insertion length .480"
Certifications***	UL Type 12 & 13 File #: E256847; CE

R-3MT TERMINATIONS

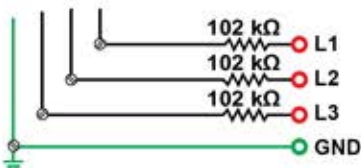

Note:
Test Point Assembly with 102 kΩ impedance on L1, L2, and L3 affects voltage readings - 2%.



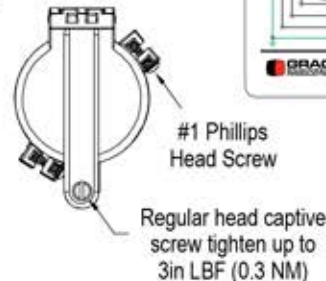
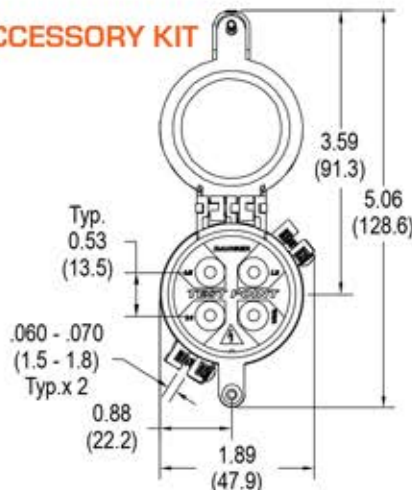

ACCESSORY KIT



R-3MT-KIT-H



R-3W SERIES VOLTAGE INDICATOR AND SAFE-TEST POINT™ COMBO TECHNICAL SPECIFICATIONS

 <p>All R-3W combos supplied with R-3MT, label and dust cap.</p>	 <p>R-3WMT-LMH</p>	 <p>R-3W2MT-LMF</p>	 <p>R-3WSMT-LMH</p>	 <p>R-3WAMT-LMF</p>
SERIES	R-3W	R-3W2	R-3WSR	R-3WA-RA
Product Number	R-3WMT-LMH* R-3WMT-LMF*	R-3W2MT-LMH* R-3W2MT-LMF*	R-3WSMT-LMH* R-3WSMT-LMF*	R-3WAMT-LMH* R-3WAMT-LMF*
Voltage Indicator	Flashing red LEDs	Flashing red LEDs Class 1, Div 2	Non-flashing red LEDs	Flashing amber ground LEDs
Label Dimensions	Horizontal - 5"H x 6.50"W Flange - 12.188"H x 1.90"W			
Operating & Storage Temperature	Operate: -20°C to +55°C Storage: -45°C to +85°C			
Operational Range AC Single or 3-Phase	40-600VAC 50/60Hz	40-600VAC 50/60/400Hz	40-600VAC 50/60Hz	40-600VAC 50/60Hz
Operational Range DC or Stored Energy	30 to 600 VDC			
Wire Specifications	PVC insulated with nylon jacket, 6ft, 18AWG Wire, 90°C @ 1000V, UL 1452, pre-stripped and tinned			
Certifications***	UL 4X, 12 & 13 File #: E256847; CE	UL Type 4X, 12, 13 HAZ. LOC. 42RV, 46RD File #: E334957; CE	UL 4X, 12 & 13 File #: E256847; CE	UL 4X, 12 & 13 File #: E256847; CE

Special configurations and custom labels available upon request. Contact your sales representative for more information today.

EQUIPMENT REQUIREMENTS

Voltage test instrument with 1000V AC/DC rated input minimum, a typical 10MΩ input impedance and CAT III & IV. A pair of insulated test probes with .080" DIA. points with minimum probe insertion length of .480".

*Part numbers ending in H are horizontal mount units and labels. Part numbers ending in F are flange mount units and labels.

**Safe-Test Point™ is recommended to be used with supplied dust cap and label (assembly required).

***Dust cap and label are not UL or CE certified.

FOR MORE INFORMATION VISIT PESD.COM OR CALL 1.800.280.9517

Warning: Verify an electrical conductor has been de-energized using an adequately rated test instrument before working on it. Follow appropriate Energy Control (Lockout/Tagout) procedures as per OSHA Subpart S.

© Grace Engineered Products, Inc. All rights reserved. Specifications are subject to change with/without notice.



FREQUENTLY ASKED QUESTIONS

Q: What is the shock hazard when using this device?

A: *This high impedance device limits the available current at the test points to 4.7mA at 480V and 5.7mA at 600V. According to OSHA document 3075 (2002) page 7, "any shock hazard under 6mA is considered a slight shock; uncomfortable, but not painful."*

Q: What would a typical Lockout/Tagout (LOTO) procedure include with this device?

A: *Follow NFPA 70E Article 120.1 Verification of an Electrically Safe Work Condition. The R-3MT allows voltage measurements from phase to phase and phase to ground to check for presence and absence of voltage safely from outside the enclosure.*

Q: Where do I install the Safe-Test Point™ on my equipment?

A: *Safe-Test Point™ can be directly wired to either the load side or line side of the LOTO voltage source point. It can also be directly wired onto the bus below the fuses to measure a blown fuse or a tripped circuit breaker.*

Q: What are the recommended connection accessories for Safe-Test Point™?

A: *Recommendations may vary based on application, however, we suggest the following connectors: T&B Sta-Kon Series, 3M Scotchlok, Wago 773 Series, or Wago 222 Series.*

Q: Do I need Personal Protective Equipment (PPE)?

A: *Use the recommended PPE based on your facility's electrical safety program and adhere to the PPE guidelines in Table 130.7 (C)(16) of the NFPA 70E.*

Q: What are the added benefits of the voltage indicator?

A: *The voltage indicator provides a redundant verification and visual representation of voltage absence and presence from outside the door. In addition, the voltage indicator provides the indication of a blown fuse and/or phase loss in the circuit.*

Q: How do I perform a "live-dead-live" test with this device?

A: *Always follow the "live-dead-live" test procedure as per OSHA and NFPA 70E (2015), Article 110.4(A)(5), 120.1, and Annex G. Sample procedure—with a properly rated test instrument, verify the test instrument to a known source, then insert the test probes into the R-3MT test point assembly to verify the presence of voltage. Next, open the isolator and proceed to verify the absence of voltage on the R-3MT assembly by measuring L1-L2, L1-L3, L2-L3, L1-G, L2-G and L3-G. Once you have verified voltage absence, re-verify the test instrument to a known source.*

Q: Can I use this device without the dust cap?

A: *We recommend installing the dust cap on the R-3MT for each installation. The dust cap provides tool access for qualified personnel and also helps keep dust and contaminants away from the individual test points.*

Q: Do I need to follow any other safety procedures?

A: *Always follow the safety procedure established by your facility and/or employer; in addition, we suggest following a sample procedure outlined on the assembly instructions provided with the Safe-Test Point™.*

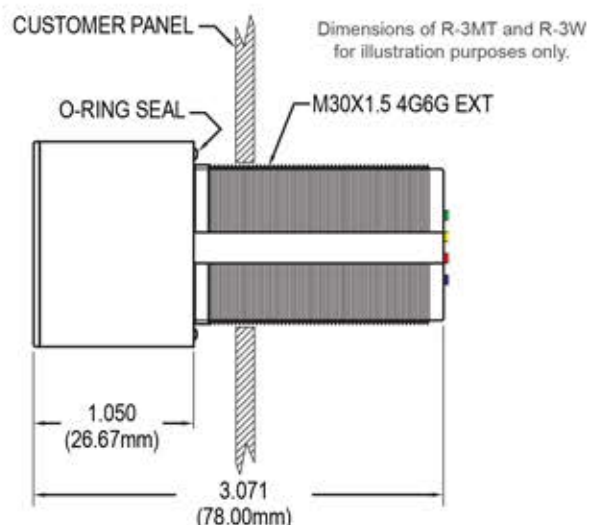

Warning: Verify an electrical conductor has been de-energized using an adequately rated test instrument before working on it. Follow appropriate Energy Control (Lockout/Tagout) procedures as per OSHA Subpart S.

© Grace Engineered Products, Inc. All rights reserved. Specifications are subject to change with/without notice.



D-3MT-DS-0416-EN