

PANEL CUTOUT

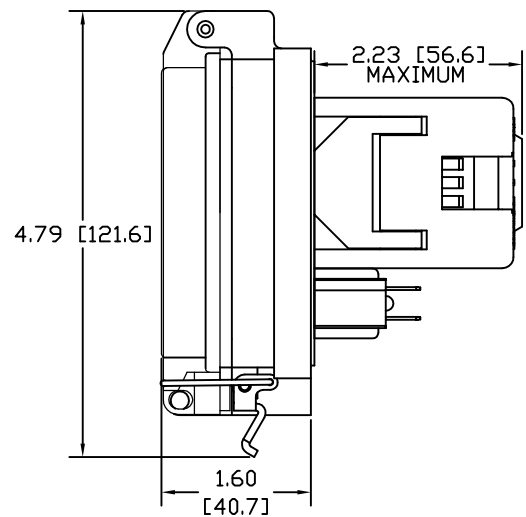
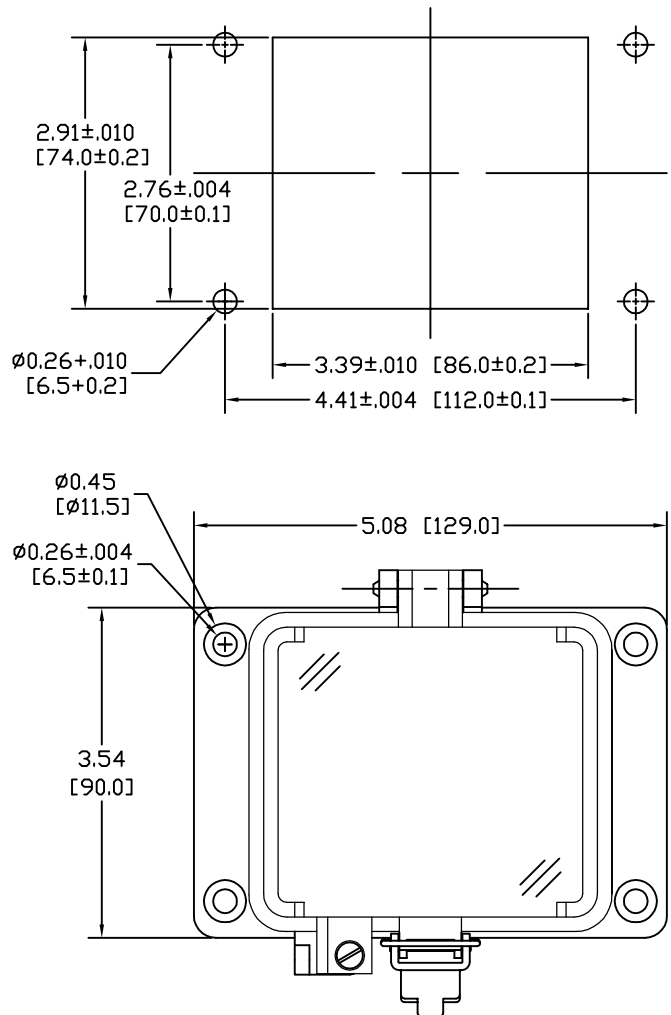

- NOTE:
- 1.) HOUSING INSERTS COMPONENT LOCATIONS ARE APPROXIMATE.
 - 2.) HOUSINGS ARE UL RECOGNIZED TYPE 12 OTHER ENVIRONMENTAL RATINGS MAY APPLY.
 - 3.) FINAL ASSEMBLIES: UL RECOGNIZED, CSA, AND CE MAY APPLY CONSULT FACTORY.
 - 4.) COVERS: CLEAR, UL V0 FLAME RATING, & UV RATED.

GracePort(R) is a Registered Trademark of Grace Engineered Products, Inc.
Property of Grace Engineered Products, Inc.